

ThermTec

ARES
2.0

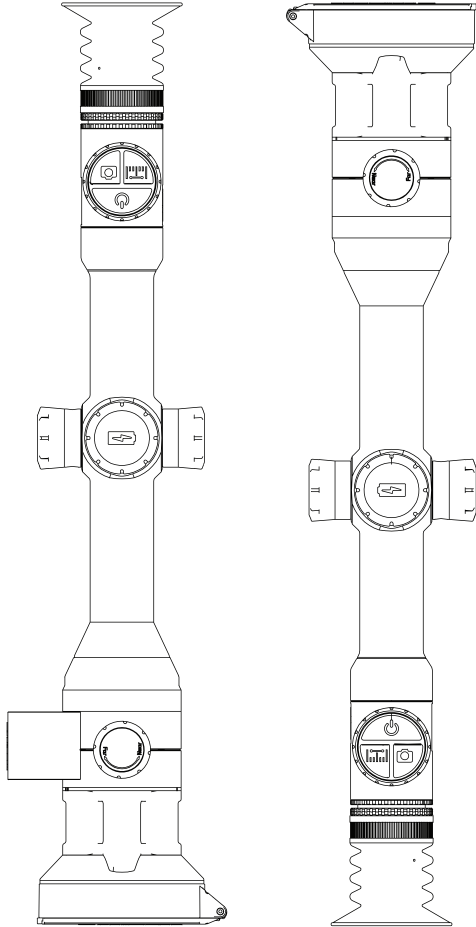
Thermal Imaging Scope ARES 2.0 & ARES LRF 2.0 SERIES User Manual



Download on the
App Store

GET IT ON
Google Play





CE

UK
CA

RoHS



Table of Contents

About This Manual	5	5.4.2 Objective Lens Focusing	19
Regulatory Information	6	5.4.3 Digital Adjustment of Focus Distance	20
1. Introduction	7	5.4.4 FOV Selection and Shifting	20
1.1 Device Description	7	5.5 Shortcut Menu	20
1.2 Features	8	5.6 Color Plate	23
1.3 Detection Range	9	5.7 Image Settings	24
1.4 Cautions	9	5.8 Settings	25
2. Packing List	10	5.9 Zeroing	29
3. Specifications	12	5.9.1 Automatic Zeroing	30
4. Appearance	14	5.9.2 Manual Zeroing	30
4.1 Dimensions	14	5.9.3 Trajectory	32
4.2 Buttons and Controls	16	5.10 Reticles	33
5. Operation Guide	17	5.11 Blind Pixel	34
5.1 Battery Installation	17	6. Network Connection	34
5.2 Power-on the Device	18	6.1 App Download	34
5.3 Main Menu	18	6.2 Connection via Hotspot	34
5.4 Lens Adjustment	19	7. Firmware Upgrade	35
5.4.1 Diopter Adjustment	19	7.1 Upgrade via PC	35
		7.2 Upgrade via Mobile Application	35

About This Manual

COPYRIGHT © 2024 ThermTec Technology Co., Ltd. ALL RIGHTS RESERVED.

Any and all information, including, among others, wording, pictures, graphs are the properties of ThermTec Technology Co., Ltd. or its subsidiaries (hereinafter referred to be “ThermTec”). This user manual (hereinafter referred to be “the Manual”) cannot be reproduced, changed, translated, or distributed, partially or wholly, by any means, without the prior written permission of ThermTec. Unless otherwise stipulated, ThermTec does not make any warranties, guarantees or representations, express or implied, regarding to the Manual.

This Manual is applicable to Thermal Imaging scope.

The Manual includes instructions for using and managing the product. Pictures, charts, images, and all other information hereinafter are for description and explanation only. The information contained in the Manual is subject to change, without notice, due to firmware updates or other reasons.

Regulatory Information



This product and, if applicable, the supplied accessories are marked with “CE” and comply therefore with the applicable harmonized European standards listed under the Radio Equipment Directive 2014/53/EU, the EMC Directive 2014/30/EU, the RoHS Directive 2011/65/EU.



This product and - if applicable - the supplied accessories too are marked with “UKCA” and comply therefore with the following directives: Radio Equipment Regulations 2017, Electromagnetic Compatibility Regulations 2016, Electrical Equipment (Safety) Regulations 2016, the Restriction of the Use of Certain Hazardous Substances in Electrical and Electronic Equipment Regulations 2012.



This product and - if applicable - the supplied accessories too are marked with “RoHS” and comply therefore the requirements of Directive 2011/65/EU on the restriction of the use of certain hazardous substances in electrical and electronic equipment (“RoHS recast” or “RoHS 2”).



2012/19/EU (WEEE directive): Products marked with this symbol cannot be disposed of as unsorted municipal waste in the European Union. For proper recycling, return this product to your local supplier upon the purchase of equivalent new equipment, or dispose of it at designated collection points.

For more information see: www.recyclethis.info.



Directive 2006/66/EC and its amendment 2013/56/EU (Battery Directive): This product contains a battery that cannot be disposed of as unsorted municipal waste in the European Union. See the product documentation for specific battery information. The battery is marked with this symbol, which may include lettering to indicate cadmium (Cd), lead (Pb), or mercury (Hg). For proper recycling, return the battery to your supplier or to a designated collection point.

For more information see: www.recyclethis.info.

1 Introduction

1.1 Device Description

ARES 2.0 & ARES LRF 2.0 Series thermal imaging scope is equipped with 12 μm high-sensitivity detector with the resolution up to 640 x 512, which features a dual-field of view with 20mm/60mm focal lengths, a 1024x768 high-definition OLED display, as well as an AI/laser rangefinder, providing a clear view over long distances in harsh environments, poor visibility, or even total darkness. ARES(L) 2.0 allows users to see through obstacles that hinder the detected target and accurately measure the actual distance to the target. In addition, it's easy to connect to our mobile application to achieve live view and share your findings.

ARES 2.0 & ARES LRF 2.0 Series thermal imaging scope facilitates applications in a wide range of fields, including observation, night hunting, rescue operations, hiking, traveling, and more.



1.2 Features

Dual FOV (Ares 360(L)/660(L) 2.0 Only)

Equipped with unique dual FOV and 3x optical zoom, ARES(L) 2.0 allows users to switch between two different focal lengths of FOV quickly and manually. A wider FOV with a focal length of 20mm is used for target search, while a narrower FOV with a focal length of 60mm is used for target identification.

Auto Zeroing

With the function of “First-Shot Auto-Zeroing” and the storage capacity of up to five zeroing profiles including zeroing coordinates, distances and gun types, ARES 2.0 meets the users’ convenience without re-zeroing when switching guns.

AI/Laser Rangefinder

The AI/laser rangefinder realizes the distance measurement to targets over a large range, ensuring the accuracy of every shot.

Recoil Activated Video (RAV)

With RAV, it records videos before, during, and after your shot, capturing the footage of your hunting moments.

Trajectory (Ares-L 2.0 Only)

Due to our advanced algorithms, POA suggestions will be provided to help users overcome the impact of bullet drop during long-distance shooting, further improving the shooting accuracy.

Automatic Object Detection (Ares 2.0 Only)

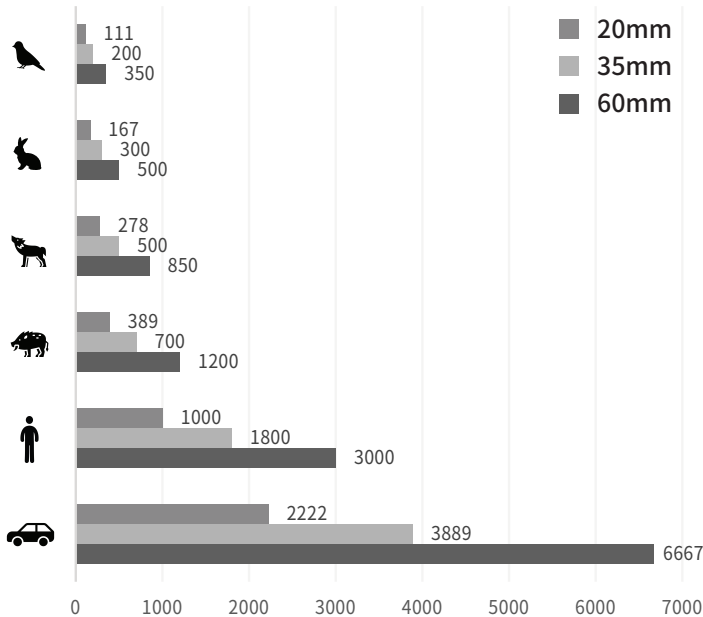
After connecting to the wireless network, the mobile APP will automatically send a notification when the scope detects the target, ensuring that users do not miss any object entering their field of view.

Picture-in-Picture Function

In picture-in-picture mode, it displays a magnified image at the top-center of the overall field of view with aligned crosshairs and ½ mil FFP reticle when zooming in on an object of interest.

1.3 Detection Range

The illustration below shows the comparative range performance of the device with different lens configurations. The data is based on detecting a car (4m), a man (1.8m tall), a wild boar (0.7m tall), a wolf (0.5m tall), a rabbit (0.3m tall), and a bird (0.2m tall).



1.4 Cautions



CAUTION



Avoid hard objects.



Do not aim the lens directly at the sun or high-temperature light sources.



Do not use the device in extremely cold or hot environment.



Charge the battery once every three months when it is not used for a long period of time.



Do not irradiate the laser indicator of the device to human eyes.



Never disassemble or modify the device on your own.

2 Packing List – Ares 2.0



Scope (x1)



30mm tube clip (x2)



18650 battery cap (x1)



Lithium battery (x2)



USB cable (x1)



Charger (x1)



Eyeshade (x1)



Lens cloth (x1)



18500 battery cap (x1)



Packing List - Ares LRF 2.0



Scope (x1)



30mm tube clip (x2)



18650 battery cap (x1)



Lithium battery (x2)



USB cable (x1)



Charger (x1)



Eyeshade (x1)



Lens cloth (x1)



18500 battery cap (x1)



3

Specifications Ares 2.0

Model	ARES335 2.0	ARES360 2.0	ARES650 2.0	ARES660 2.0
Microbolometer				
Type	Uncooled			
Resolution	384x288		640x512	
Pixel pitch	12µm			
NETD	≤18mK	≤20mK	≤18mK	≤20mK
Spectral range	8-14µm			
Frame rate	50HZ			
Detection Range	1800m	1000/3000m	2600m	1000/3000m
Optics				
Objective lens	35mm, F1.0	20/60mm, F1.0	50mm, F1.0	20/60mm, F1.0
Field of view	7.5°x5.6°	13.1°x9.8°/ 4.4°x3.3°	8.8° x 7.0°	21.7°x17.4°/ 7.3°x5.9°
m@100m	13.2x9.9	23x17.3/7.7x 5.8	15.4x12.3	38.4x30.7/12.8x 10.2
Magnification	3.2X	1.8X/5.5X	2.8X	1.1X/3.2X
Digital zoom	1.0-4.0X smooth & rapid zoom			
Eye relief	50mm			
Exit pupil	6mm			
Dioptr	±5D			
Aiming Reticle				
Reticle	7			
Reticle color	5, Black, white, red, green, blue			
Display				
Type	AMOLED			
Resolution	1024x768			
Display size	0.39 inch			
Color palette	6			

Function				
Max. recoil power on rifled weapon	6000J			
Mounting brackets on weapon	Standard 30mm rings			
RAV	Yes			
Audio Recording	Yes			
Auto zeroing	Yes			
Manual zeroing	Yes			
Zeroing profiles	5			
Freeze Zeroing	Yes			
Picture-in-picture	Yes			
AI ranging	Yes			
Image calibration	Manual/Auto			
Video Recorder				
Phone/video playback	Yes			
Inbuilt memory	64GB			
Interface				
Type C	Data transfer			
Hotspot	Yes			
Battery				
Battery type	Replaceable, 1*18650 or 18500 battery, 1*18650 inbuilt battery			
Battery reverse connection	Yes			
Battery life	18h	18h	16h	16h
Environment				
Operating temperature	-20- +50°C			
IP rating	IP67			
Weight, g	814	1072	873	1072
Size, mm	391.8*80.7*82.2	435.7*89.5*92.9	404.8*84.7*84.9	435.7*89.5*92.9
Accessories				
External cable	USB data cable			
Other accessory	2x standard 30mm rings, eyeshade and etc.			

Specifications

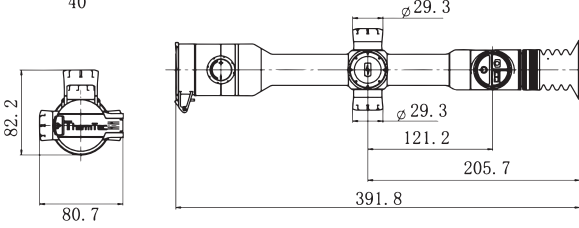
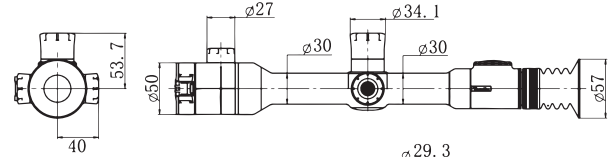
Ares LRF 2.0

Model	ARES335L 2.0	ARES360L 2.0	ARES650L 2.0	ARES660L 2.0
Microbolometer				
Type	Uncooled			
Resolution	384x288		640x512	
Pixel pitch	12μm			
NETD	≤18mK	≤20mK	≤18mK	≤20mK
Spectral range	8-14μm			
Frame rate	50HZ			
Detection Range	1800m	1000/3000m	2600m	1000/3000m
Optics				
Objective lens	35mm, F1.0	20/60mm, F1.0	50mm, F1.0	20/60mm, F1.0
Field of view	7.5°x5.6°	13.1°x9.8°/ 4.4°x3.3°	8.8° x 7.0°	21.7°x17.4°/ 7.3°x5.9°
m@100m	13.2x9.9	23x17.3/7.7x 5.8	15.4x12.3	38.4x30.7/12.8x 10.2
Magnification	3.2X	1.8X/5.5X	2.8X	1.1X/3.2X
Digital zoom	1.0-4.0X smooth & rapid zoom			
Eye relief	50mm			
Exit pupil	6mm			
Dioptr	±5D			
Aiming Reticle				
Reticle	7			
Reticle color	5, Black, white, red, green, blue			
Display				
Type	AMOLED			
Resolution	1024x768			
Display size	0.39 inch			
Color palette	6			

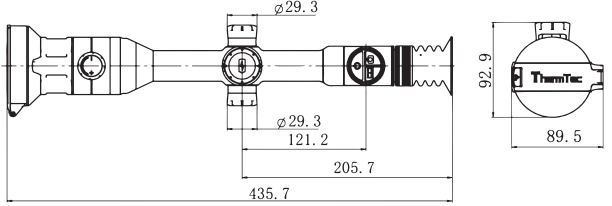
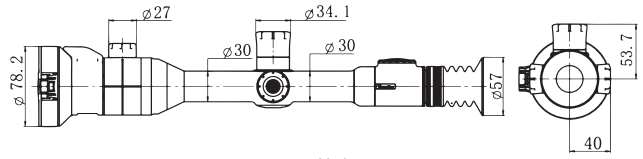
Function				
Max. recoil power on rifled weapon	6000J			
Mounting brackets on weapon	Standard 30mm rings			
RAV	Yes			
Audio Recording	Yes			
Auto zeroing	Yes			
Manual zeroing	Yes			
Zeroing profiles	5			
Freeze Zeroing	Yes			
Picture-in-picture	Yes			
Laser ranging	1.8mrad@1000m			
Ballistic Calculator	Yes			
Image calibration	Manual/Auto			
Video Recorder				
Phone/video playback	Yes			
Inbuilt memory	64GB			
Interface				
Type C	Data transfer			
Hotspot	Yes			
Battery				
Battery type	Replaceable, 1*18650 or 18500 battery, 1*18650 inbuilt battery			
Battery life	18h	18h	16h	16h
Environment				
Operating temperature	-20- +50°C			
IP rating	IP67			
Weight, g	849	1117	918	1117
Size, mm	391.8*85.3*82.2	435.7*103.9*92.9	404.8*92.2*84.9	435.7*103.9*92.9
Accessories				
External cable	USB data cable			
Other accessory	2x standard 30mm rings, eyeshade and etc.			

4

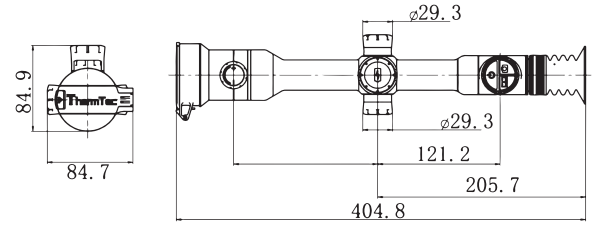
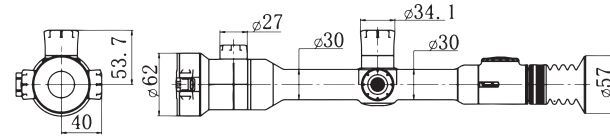
Appearance 4.1 Dimensions



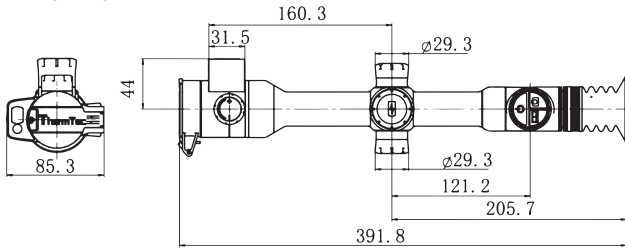
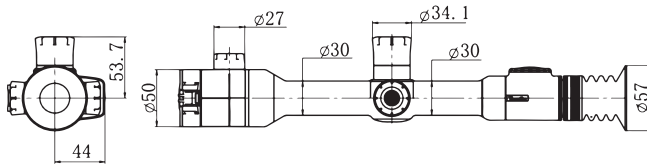
ARES 335 2.0



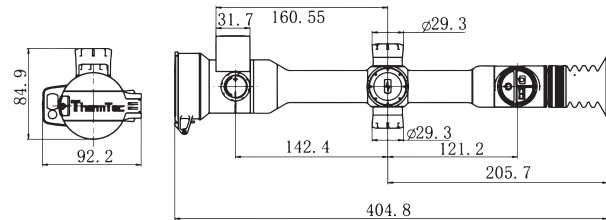
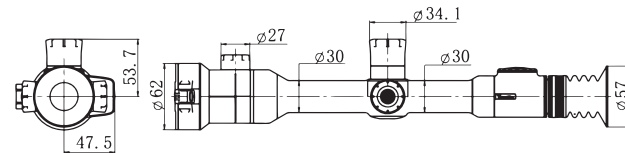
ARES 360/660 2.0



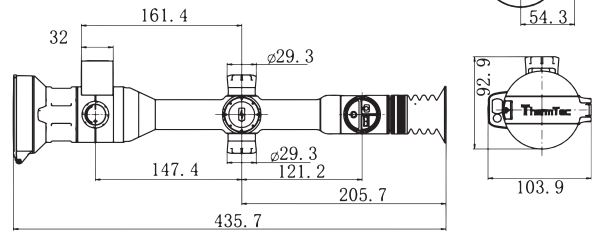
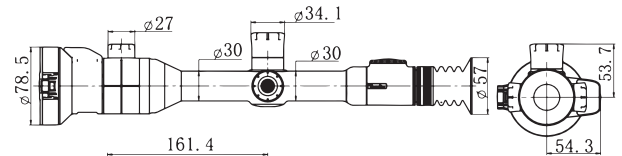
ARES 650 2.0



ARES 335L 2.0






ARES 650L 2.0




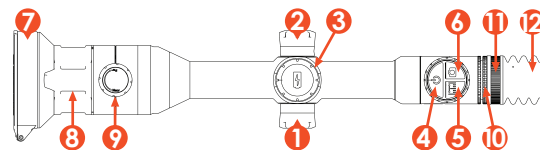
ARES 360/660L 2.0

Notes: the size of battery cap marked in the drawings refers to 18650 battery cap, which can be replaced by 18500 battery cap.

4.2 Buttons and Controls

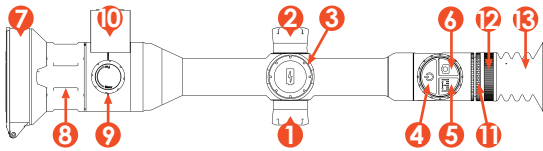
		Short Press	Long Press	Double Press
	Power ON/OFF	Enter standby mode and screen locked	ON/OFF	N/A
	AI/Laser Rangefinder	AI/Laser Rangefinder Function On/OFF	Target Outline Mode On/OFF (Ares-L Only)	Color Plates Shift
	Capture/Record	Take photos	Take videos	PIP on/off

Before the Entry of Main Menu				
 Rotary Knob	Rotate Knob	Short Press and Rotary Knob	Long Press	Double Press
	Zooming	Brightness/contrast adjustment	Entry of main menu	Image calibration
	After the Entry of Main Menu			
	Rotate Knob	Short Press	Long Press	Double Press
	Up/down for Selection	Confirm	Exit	N/A



ARES2.0

- 1 Rotary Knob
- 2 USB Port
- 3 Battery Slot
- 4 Power Button
- 5 AI Rangefinder Button
- 6 Capture/Record Button
- 7 Objective Lens
- 8 Dual-FOV Switch (for Ares360/660 2.0)
- 9 Focusing Knob
- 10 Diopter Adjustment
- 11 Eyepiece
- 12 Eyeshade



ARES LRF 2.0

- | | |
|----|---|
| 1 | Rotary Knob |
| 2 | USB Port |
| 3 | Battery Slot |
| 4 | Power Button |
| 5 | Laser Rangefinder Button |
| 6 | Capture/Record Button |
| 7 | Objective Lens |
| 8 | Dual-FOV switch (for Ares360L/660L 2.0) |
| 9 | Focusing Knob |
| 10 | Laser Rangefinder Module |
| 11 | Diopter Adjustment |
| 12 | Eyepiece |
| 13 | Eyeshade |

5 Operation Guide

5.1 Battery Installation

Unlike Ares(L) 1.0 series, the operation of battery installation is the same for all models of Ares(L) 2.0 series. Please refer to the following figure for the installation of the replaceable battery.



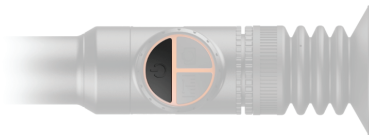
Notes: The positive pole must be installed inwards.

1. The battery icon on the left side indicates the electric quantity of the replaceable battery.
2. The battery icon on the right side indicates the electric quantity of the built-in battery.



1 2

5.2 Power-on the Device



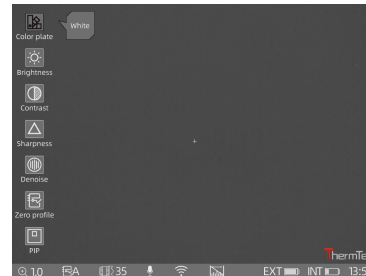
Power button

Users could long press the power button to power on/off the device.

In addition, it is available to short press the power button to enter device's standby mode to keep the screen locked.

5.3 Main Menu

Long press the middle of the rotary knob to enter the main menu. After the entry of Main Menu, short press the button for the operation of "Confirmation", and long press the button for the operation of "Exit". Rotating the knob is the operation of moving the cursor.



Main Menu

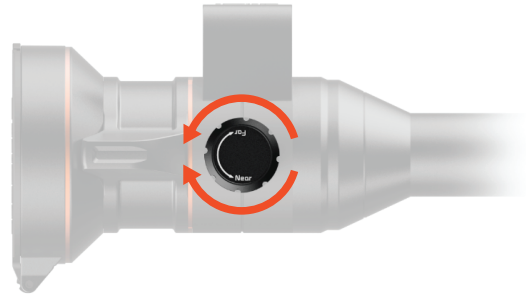
5.4 Lens Adjustment

5.4.1 Diopter Adjustment

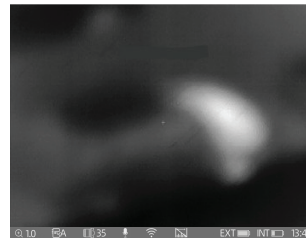
Slowly rotate the diopter adjustment ring to adjust the position of diopter level to optimize the image sharpness on the OLED display.



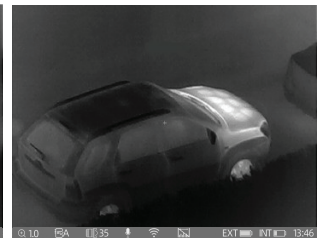
Aim at the target and rotate the focusing knob until the image of object is clear.



Both clockwise and anticlockwise rotation of the focusing knob are allowed.



Focus on the Selected Target



Focusing Finished

5.4.2 Objective Lens Focusing

Manually adjust the focusing knob when necessary.

5.4.3 Digital Adjustment of Focus Distance

On the main screen, rotate the knob to digitally adjust the focus distance.



Rotate upward for zooming in, and rotate the knob downward for zooming out.



5.4.4 FOV Selection and Shifting (for Ares360(L) 2.0 and Ares660(L) 2.0)

The device is equipped with dual-field of view. Rotate the lens to shift the field of view from 20° to 60° or from 60° to 20°.



Shift the FOV
from 60° to 20°



FOV successfully
shifted

5.5 Shortcut Menu

5.5.1 Taking photos/videos



Take photos-short press the Capture/Record button;
Take videos - long press the Capture/Record button.

5.5.2 AI/Laser Ranging



Notes: AI ranging function is available for the models of Ares 2.0 series, while laser ranging function is available for the models of Ares LRF 2.0 series.

AI/Laser Rangefinder - short press the AI/Laser Rangefinder button to turn on/off the AI/laser rangefinder.

5.5.3 Pseudo Color Shift



Pseudo color switch - double press the button to switch the pseudo colors.

5.5.4 Target Outline Mode (Ares-L 2.0 Only)



Target Outline Mode - long press the button to turn on/off the Outline Mode.

5.5.5 Standby Mode



Standby mode - short press the Power button

5.5.6 Contrast Adjustment



Short press the middle of the rotary knob to enter the Contrast screen.



The screen of Contrast Adjustment by clicking the shortcut button



Rotate the knob to increase or decrease the contrast degree.

5.5.7 Brightness Adjustment



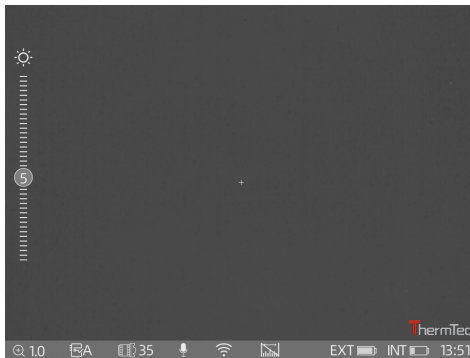
Shortcut button: short press the rotary knob to enter the Brightness screen.



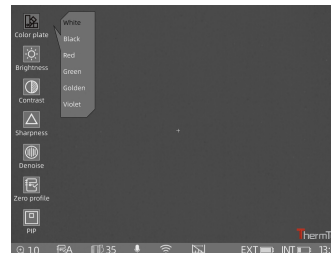
Rotate the knob to increase or decrease the brightness degree.

5.6 Entry of the Main Menu

Long press the middle of the rotary knob to enter the main menu. After the entry of Main Menu, short press the button for the operation of “Confirmation”, and long press the button for the operation of “Exit”. Rotating the knob is the operation of moving the cursor.



The screen of Brightness Adjustment by clicking the shortcut button



Color Plate

Color Palettes



White



Black



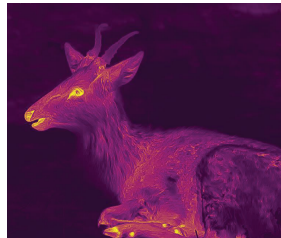
Red



Green







Golden







Violet

5.7 Image Settings



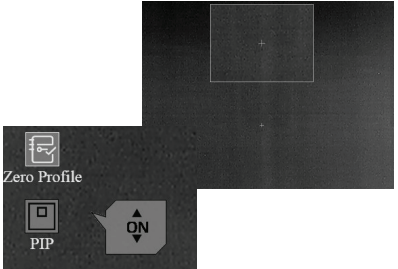
There are four sub-menus for image settings, which are “Brightness”, “Contrast”, “Sharpness” and “Denoise”. Short press the rotary knob to enter these sub-menus, and rotate the knob to adjust the images.


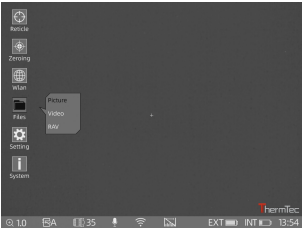



Image Setting Sub-menus	
<p>Brightness</p> 	<p>1-10 Adjust the image brightness to make the image brighter. The recommended value is 5.</p> 
<p>Contrast</p> 	<p>1-10 Adjust the image contrast to make the object more prominent in the image. The recommended value is 5.</p> 




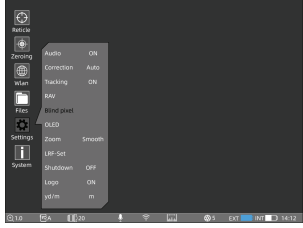
<p>Sharpness</p> 	<p>1-10</p>	<p>Adjust the image sharpness to make the edges of the image sharper. The recommended value is 5.</p> 
<p>Denoise</p> 	<p>0-10</p>	<p>Adjust the image noise to make the image cleaner. The recommended value is 5.</p> 

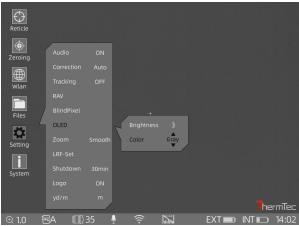


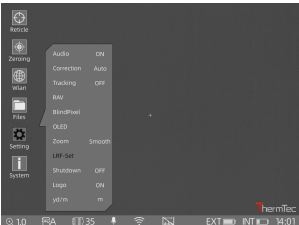
5.8 Settings

Short press the rotary knob to enter the sub-menus of Settings, and rotate the knob to adjust the parameters accordingly.

Sub-menus of Settings																																
<p>Zeroing profiles</p> 	<p>A-E</p>	<p>There are five zeroing profiles from "A-E" in the file folder, which contain the distance, type of bullet, and the coordinates of the crosshairs after zeroing.</p> <table border="1" data-bbox="954 389 1264 568"> <tr> <td>A</td> <td>Distance</td> <td>m</td> <td>Gun</td> <td>X=</td> <td>Y=</td> </tr> <tr> <td>B</td> <td>Distance</td> <td>m</td> <td>Gun</td> <td>X=</td> <td>Y=</td> </tr> <tr> <td>C</td> <td>Distance</td> <td>m</td> <td>Gun</td> <td>X=</td> <td>Y=</td> </tr> <tr> <td>D</td> <td>Distance</td> <td>m</td> <td>Gun</td> <td>X=</td> <td>Y=</td> </tr> <tr> <td>E</td> <td>Distance</td> <td>m</td> <td>Gun</td> <td>X=</td> <td>Y=</td> </tr> </table>	A	Distance	m	Gun	X=	Y=	B	Distance	m	Gun	X=	Y=	C	Distance	m	Gun	X=	Y=	D	Distance	m	Gun	X=	Y=	E	Distance	m	Gun	X=	Y=
A	Distance	m	Gun	X=	Y=																											
B	Distance	m	Gun	X=	Y=																											
C	Distance	m	Gun	X=	Y=																											
D	Distance	m	Gun	X=	Y=																											
E	Distance	m	Gun	X=	Y=																											
<p>Picture-in-Picture</p> 		<p>The image is enlarged by 2x as centered by the crosshairs. Picture-in-picture occupies 10% of the entire image.</p> 																														

<p>Files</p> 	<p>Picture</p>	<p>Open the sub-menu of Picture, and rotary the knob to select the images.</p> 
	<p>Video</p>	<p>Open the sub-menu of Video, and rotary the knob to select the videos.</p> 
<p>Setting</p> 	<p>Correction</p>	<p>The image correction mode could be set to Auto or Manual.</p> 





	<p>Tracking</p>	<p>Turn on heat tracking function to mark the hottest target on the screen in real time.</p> 
<p>Setting</p> 	<p>RAV</p>	<p>After turning on the RAV, the scope will record videos before, during and after your shot. The threshold can be modified manually for different weapons and ammunitions.</p> 
	<p>BlindPixel</p>	<p>User can operate blind spot replaced function when pups up blindness.</p> 

	<p>OLED</p> 
<p>Setting</p> 	<p>Zoom</p> 
	<p>LRF-Set</p> 

The color of OLED can be selected from red, blue, purple and gray.

Smooth: The speed of zooming is more even. Rapid: Integer zooming, suitable for fast moving target tracking.



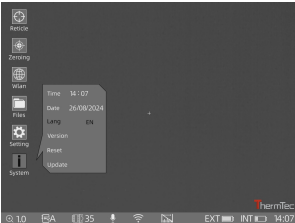
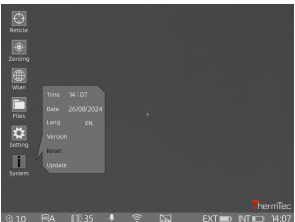
It includes the default information of LRF location. Warning: No modification is allowed in this section.


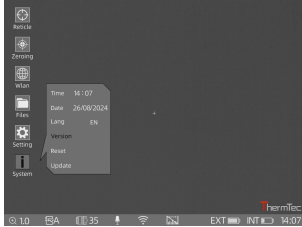
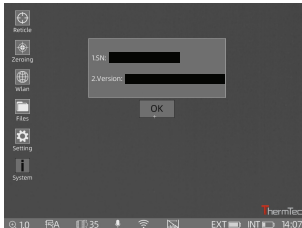
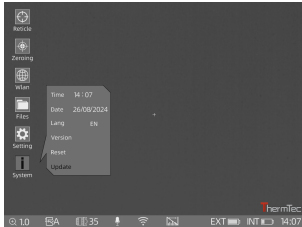
	<p>Shutdown</p> 
<p>Setting</p> 	<p>Logo</p> 
	<p>yd/m</p> 

Turn on the Auto Shutdown if needed to avoid prolonged standby of device. Three options: 30 mins, 60 mins, 90mins.

Show or hide the Logo in the captured images or videos.

Change the distance measurement unit between yard and meter as you want.

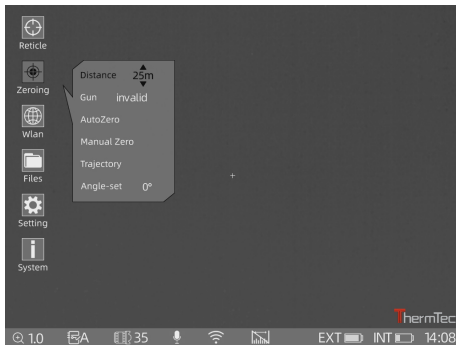
System 	Date	<p>Adjust the local date manually.</p> 
	Language	<p>The language of the current system.</p> 
	Reset	<p>After resetting, the configuration parameters are restored to the factory state.</p> 

System 	Version	<p>View the SN number and firmware version of the device.</p>  
	Update	<p>The system of the device can be updated and upgraded.</p> 

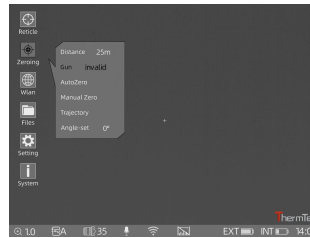
5.9 Zeroing

Enter the Main Menu, rotate the knob and short press the rotary knob to enter the sub-menu of Zeroing.

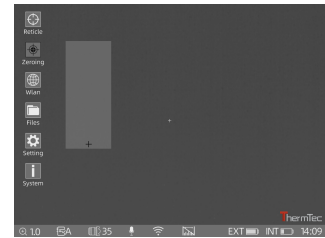
- ① Short press the rotary knob one more time. Rotate and short press the knob to select and confirm the zeroing distance (e.g. 25m or 35m).
- ② After that, move the cursor and short press the rotary knob to enter the Gun Type screen.
- ③ Rotate the knob anticlockwise until “+” appears.
- ④ Short press the rotary knob to add the Gun Type (customizable; press “Enter” on keyboard to add the Gun Type).
- ⑤ Rotate the knob clockwise and short press the rotary knob to select the Gun Type. Long press the rotary knob to return to the previous screen.



5.9 ①



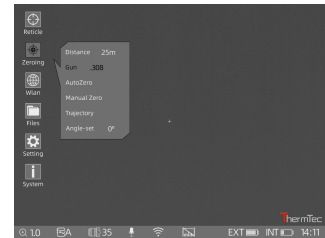
5.9 ②



5.9 ③



5.9 ④



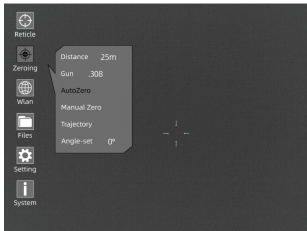
5.9 ⑤

Notes:

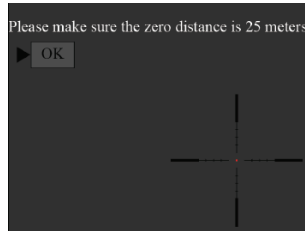
- 1.It is recommended to do Zeroing at a temperature that close to the scope’s operating temperature.
- 2.The FOV of lens with focal length of 20mm or 60mm needs to be zeroed in the same way respectively. The zeroing profile for FOV that with focal lengths of 20mm and 60mm should be consistent.

5.9.1 Auto Zeroing

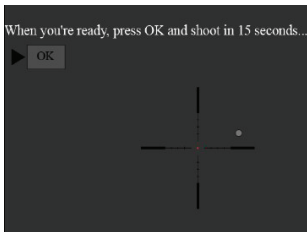
- ① Rotate the knob anticlockwise, and move the cursor to Auto Zero.
- ② Short press the rotary knob to enter the Auto Zeroing screen. Confirm the zeroing distance, and short press the “OK” button to enter the next step.
- ③ When you are ready, press “OK” and finish the shooting within 15s.
- ④ Short press the rotary knob to save the zeroing data to any profile (A, B, C, D, E). Finally, long press the rotary knob to exit.



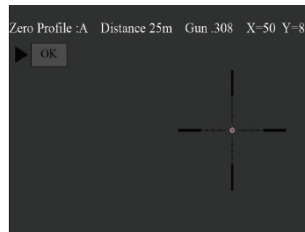
5.9.1 ①



5.9.1 ②



5.9.1 ③



5.9.1 ④

5.9.2 Manual Zeroing

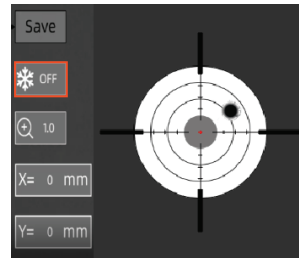
- ① Rotate the knob anticlockwise, and move the cursor to Manual Zero.
- ② Short press the rotary knob to enter the Manual Zeroing screen, confirm the zeroing distance, and short press “OK” to enter the next step.
- ③ After your first shooting is finished, align the reticle with point of aiming, and rotate the knob to turn on the Freeze function. ❄️ A screenshot will be taken. (The Freeze function allows you to freely move or manipulate the scope without losing reticle placement on the point of aim during adjustments.)
- ④ Rotate the knob to change the magnification when necessary, which helps to improve the accuracy of zeroing.
- ⑤ Adjust the coordinates (X, Y) of the reticle by rotating the knob, and move the reticle from the original position to the bullet hole position manually. After pressing the Save button, the values of X and Y will change according to the magnification. e.g. X: -20mm, Y: -20mm (1x); X: -10mm, Y: -10mm (2x); X: -4mm, Y: -4mm (5x).

Short press the rotary knob to save the zeroing data to any profile (A, B, C, D, E). Finally, long press the rotary knob to exit.

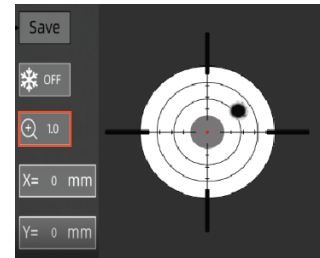
Notes:

1.The changes will always be saved based on your last calibration, e.g. the first saved coordinate is (-20mm, 35mm) in Profile A and you may want a tiny change like (-5mm,5mm), so the device finally displays (-25mm, 40mm). If you put the same weapon name and the same distance, it will take data from the previous profile.

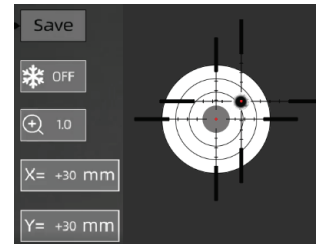
2.Please get back to the main menu to choose other profiles if you would like to save new data for another gun. It is suggested to save the subsequent changes where you first time saved for the same gun. It is not recommended to save a change in Profile A firstly then another change saved in Profile B or C.



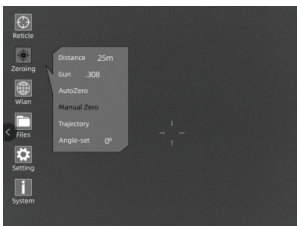
5.9.2 ③



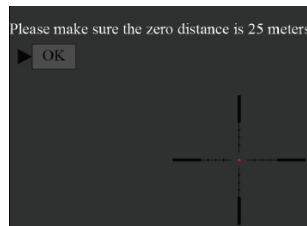
5.9.2 ④



5.9.2 ⑤



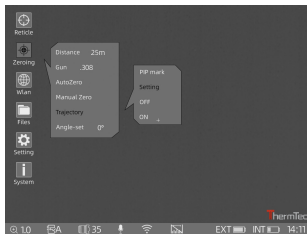
5.9.2 ①



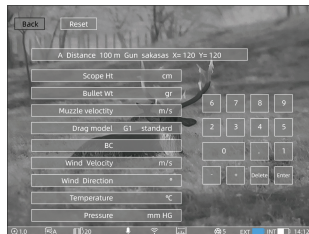
5.9.2 ②

5.9.3 Trajectory

- ① Rotate the rotary knob to move the cursor to “Trajectory”, then short press the knob to the third-level
- ② Rotate the knob again to move the cursor to “Setting”, and short press the knob. There you can configure the parameters as needed, including Scope Height, Wind Velocity, Bullet Weight, Muzzle Velocity, BC, Wind Direction, Temperature, and Pressure.
- ③ When any parameter is selected for modification, the cursor would automatically move to the keyboard section on the right side of the screen.
- ④ Click “Enter” and the cursor will return to left side of the screen.
- ⑤ Move the cursor and click the Back icon to return to the previous screen.



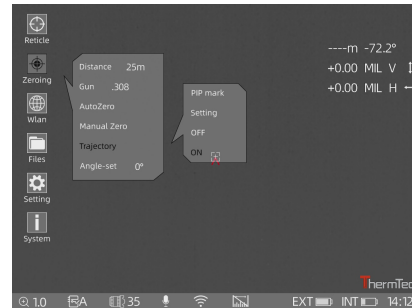
5.11 ①



5.11 ②

Hands-On:





- Users first need to move the cursor to “ON” to turn on the Trajectory function.
- After activation, an “Up Arrow” icon will appear in the center of the screen. When the icon doesn’t match the coordinates after zeroing, users should aim it at the certain target, then fill in the actual parameters into the “Setting” interface.






Attention:

- 1.Trajectory needs to be carried out after zeroing, otherwise there is no practical significance.
- 2.When Trajectory is turned on, the device will automatically switch to single ranging mode.

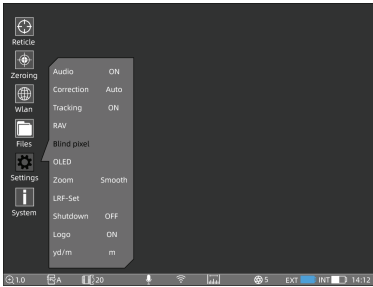
5.10 Reticles

Type	1-8	<p>Rotate the knob to select the type of reticles. There are 8 types of reticles set for selection.</p> 
Color	5 Colors	<p>Rotate the knob to select the color of reticles. There are 5 options: Black, White, Red, Green, and Blue.</p> 
Brightness	3	<p>Rotate the knob to select the brightness of reticles. There are 3 degrees of brightness set for selection.</p> 
Dot	3 Colors	<p>Rotate the knob to adjust the color of the Dot. There are 3 options: Red, Blue, and Green.</p> 

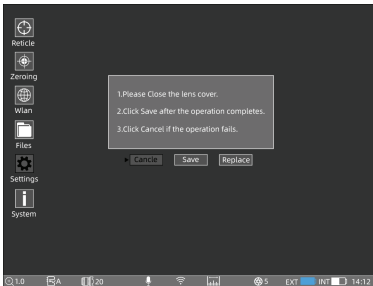
Location	Move/Center	<p>Rotate the knob to select the location of reticles. There are 2 options: "Move" and "Center". Move: Under 1x magnification, the location of the reticle keeps the same as the zeroing coordinates. The reticle will be returned to the center of the screen when image is zooming in. Center: When zeroing is finished, the screen will be slightly enlarged based on the zeroing coordinates. The reticle will be returned to the center of the screen. When zooming in or out, the reticle will always enlarge at the center of the screen.</p> 
Mode	FFP/SFP	<p>FFP: The reticle changes as zooming in; SFP: The reticle doesn't change as the zooming in;</p> 
Reversal	ON/OFF	<p>Reticle polarity reverse helps find and lock small target. (Only for Black & White Reverse)</p> 

5.11 Blind Pixel

- ① Short press the rotary knob to enter the sub-menu of “Blind Pixel” .
- ② There are three options: Cancel, Save, and Replace.
Replace: the blind pixel on the screen can be replaced. When finished, long press the middle of the rotary knob to exit.



5.11 ①



5.11 ②

6 Network Connection

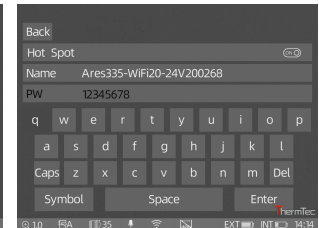
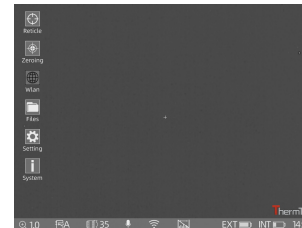
6.1 App Download

Users could download our mobile APP named “ThermTEC Outdoor” from the Apple App Store and Google Play, or by scanning the QR code on the packaging or user manual.



6.2 Connect via Hotspot

- ① Turn on the device’s Hotspot, then you can set password here.



- ② Connect your mobile phone to devices’ Hotspot via WLAN.
- ③ After successful connection, you can control devices via APP.

7 Firmware Upgrade

7.1 Upgrade via PC

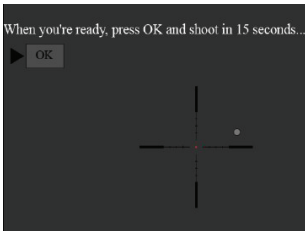
① Users could download corresponding upgrade package from our website. After that, connect your device to PC via Type-C cable and copy the firmware to device's file folder.



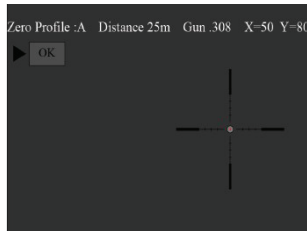
5.12 ①

② Enter the Settings menu and select "Update". A pop-up window will appear, prompting "Program Updating."

③ When the update is completed, the device will automatically restart.



5.12 ②



5.13 ③

7.2 Upgrade via Mobile Application

Ares 2.0(L) series thermal imaging scope could be interconnected with the "ThermTec Outdoor" APP, which allows users to transfer files from device to smartphone or tablet via Hotspot, easily achieving remote control.

Users could refer to the following steps to realize device firmware upgrade via our mobile APP:

- ① Open the ThermTec Outdoor APP.
- ② Turn on the Hotspot of the device, and connect your mobile phone to devices' Hotspot via WLAN.
- ③ Select "Update" from the menu options.
- ④ It will take a continuous period of time for downloading and upgrading if a new version of firmware is detected, so please be patient.
- ⑤ Once the upgrade is complete, the device will reboot automatically.



ThermTec Technology Co., Ltd.
Email: info@thermeyetec.com
Web: www.thermeyetec.com

